

SIoux TOOLS PRODUCT BROCHURE | PETRO - CHEMICAL

PETRO-CHEMICAL

I N D U S T R Y



For The
Way...
You Work!



**SIoux
TOOLS INC.**

A *Snap-on* Company

Serviceable, Rugged, Durable and Dependable

Powerful Tools for your application

Through industry research and operator input, Sioux has engineered a tool program that is designed for the way you work! No matter what Petro-chemical industry you are in, we've got you covered. From mining and drilling oil to maintenance and refurbishing, our tool program will deliver the power and durability you need. So whether you are replacing valves, working on heat exchangers and converters or just doing general maintenance, Sioux has the right tool for you.

Mission

To create and serve customers with quality products and service that meet or exceed their expectations.

A History of Success

Sioux Tools has a long and proud heritage of innovation as they have helped to shape the face of the tool industry. The company was started in November of 1914 by Swedish tool maker, Oscar Albertson, and office boy, Harold Jacobson, with a goal to become the "best machine and tool shop". Sioux has since grown to become a trusted partner by a wide range of industrial and manufacturing segments.

Originally named Albertson & Company, the first items manufactured were piston rings, spark plugs and a gas saver. They soon expanded their line to become a powerful force in the marketplace. In early 1917, Oscar Albertson designed a valve lathe- a hand tool used to seat engine valves. This invention proved to be the foundation upon which Sioux Tools has built a reputation for innovation throughout the world.

During the 1920s the company revolutionized the tool industry by introducing some of the very first hand held power tools. In 1958 the company further solidified its position as a market leader by designing and producing its first air powered tools. Today, Sioux Tools has been granted well over 100 patents. Innovation, ingenuity and insight have established Sioux tools in the minds of the professional as the tool to depend on. Our commitment to continued development in ergonomics and innovative design ensures that we will meet the needs of professionals for many years to come.

Wherever there are markets for quality-built, reliable products, backed by strong after-sale dedication to customer satisfaction, you'll find Sioux Tools. Today we continue to strive to live up to our founding father's wish of being the "best in the world".

In 1994 Sioux Tools joined Snap-on Incorporated, which added industrial power tools to the extensive Snap-on line. Snap-on Incorporated is a leading global developer, manufacturer and marketer of tool and equipment solutions for professional tool users. Product lines include hand and power tools, diagnostics and shop equipment, tool storage products, diagnostics software and other solutions for the transportation service, industrial, government, education, agricultural, and other commercial applications, including construction and electrical. Founded in 1920, Snap-on is a \$2+ billion, S&P 500 company headquartered in Kenosha, Wisconsin and employs approximately 14,000 worldwide.

Committed to your success

For over 90 years, Sioux Tools has been providing tools that have been designed and built by the best engineers in the country. We use only top-quality materials in our manufacturing process, and we offer the strongest support and warranty in the business. Our over 100 patents are an indication of our innovation in product development and design.

Sioux Tools are built tough to provide you with many years of trouble-free service. But as with any piece of equipment, service problems can occur, thus Sioux tools are designed to make servicing quick, easy and affordable.

To help ensure fast repairs, which in turn limit downtime, Sioux Tools offers training seminars that cover all the details of the tools we make. For information on our training program, please contact your local Sioux Tools representative.



TM SERIES TORQUE MULTIPLIERS

Features:

- Lightweight Titanium Gear Case - Offers 30% weight savings than standard steel gear casing
- Two Speed Gear Shift - More versatility and higher torque range
- High Quality Gears - For longer operating life expectancy between repairs
- Ergo Over Molded Grip - more comfort on the hand
- Integrated swivel joint between drive and gear case - Insures reaction-free operation over the entire bolting cycle
- Fine Pressure Control for torque pre-selection - Ultimate control
- No lateral or impact forces transmitted from tool to user - No sparks from the bolts and less vibration on the user than impact wrenches



TM50AP-4515K

Torque Multipliers

Model Number	Drive Size		Torque				Speed		Weight		Noise Level dB(A)
			Gear 1		Gear 2		Gear 1	Gear 2			
	in.	mm	ft lb	Nm	ft lb	Nm	rpm	rpm	lb	kg	
TM50AP-0775	3/4	19	45-188	61-255	125-580	169-786	69	12	10.7	4.9	84
TM50AP-0775K ¹	3/4	19	45-188	61-255	125-580	169-786	69	12	10.7	4.9	84
TM50AP-1075	1	25	59-295	80-400	220-900	298-1220	30	8	13	5.9	84
TM50AP-1075K ¹	1	25	59-295	80-400	220-900	298-1220	30	8	13	5.9	84
TM50AP-15100	1	25	40-370	54-502	150-1300	203-1763	25	7	15.6	7.1	84
TM50AP-1510K ¹	1	25	40-370	54-502	150-1300	203-1763	25	7	15.6	7.1	84
TM50AP-25100	1	25	110-600	149-813	340-2100	461-2847	9.4	2.6	22.4	10.1	84
TM50AP-2510K ¹	1	25	110-600	149-813	340-2100	461-2847	9.4	2.6	22.4	10.1	84
TM50AP-45150	1-1/2	38	160-1100	217-1491	500-3500	678-4745	6	1.7	23.1	10.5	84
TM50AP-4515K ¹	1-1/2	38	160-1100	217-1491	500-3500	678-4745	6	1.7	23.1	10.5	84
TM50AP-60150	1-1/2	38	220-1600	298-2169	650-5000	881-6779	5.3	1.5	36.3	16.5	84
TM50AP-6015K ¹	1-1/2	38	220-1600	298-2169	650-5000	881-6779	5.3	1.5	36.3	16.5	84

General:

Air Inlet Size: 1/4" NPT (Please use high flow fittings only)

Recommended Hose Size: 3/8" (10 mm)

Performance rated @ various air pressures as specified in operations manual

Standard Equipment:

Parts list, Safety and Instruction manual

Reaction arm

Metal carrying case

¹ Includes FRL Kit. If you do not own a filter regulator lubricator to operate your TM Series tools, we highly recommend that you purchase your tool with the FRL Kit included.

APPLICATIONS

Petroleum Processing

- Heat Exchanger
- Expander
- Preventer
- Converter

Blast Furnace Plants, Steel Works, Hot Rolling

- Pipe Construction, Flanges
- Pipe Welding Machine
- Blast Furnace Tongues

Non-Ferrous Metal Works

- Pipe Construction, Flanges
- Feed Pumps

Steeldrawing Plants and Cold Rolling Mills

- Rolling Mills
- Pipe Welding Tracks

Steel and Lightweight Metal Construction

- Bridge Construction
- Hall Construction
- Steel Girders
- Temporary Bridges
- Tower Crane
- Ship Deck Crane

Steelwork, Rolling Mill Equipment, Mining and Large Equipment

- Coking Plant
- Shovel Dozer
- Heading and Cutting Machine for Tunnels
- Crawler Mounted Excavator
- Hydraulic Excavator
- Crawler Type Undercarriages
- Crawler Mounted Crane
- Conveyor Systems
- Drawn up Cranes
- Crushers



TM SERIES TORQUE MULTIPLIER ACCESSORIES

Reaction Arms:

Standard reaction arms are included with each tool.
 Long or deep reaction arms are used when standard arms fall short in length. Welding rings are used to make custom reaction arms by welding the extensions to the spline ring.



STANDARD REACTION ARM

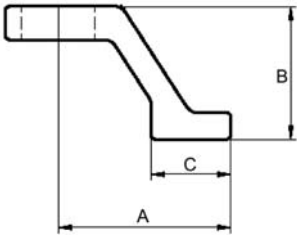

REACTION ARM

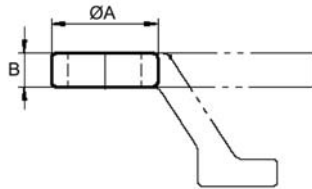

WELDING RING



WELDING RING

Standard Reaction Arms

Model Number	Tools Used On	A		B		C	
		in.	mm	in.	mm	in.	mm
RARM-1	TM50AP-0775, RATM50-07	4.33	110	3.15	80	1.97	50
RARM-2	TM50AP-1075, RATM50-10, TM50AP-15100, RATM50-15	5.12	130	3.94	100	2.36	60
RARM-3	TM50AP-25100, RATM50-25	6.69	170	5.11	129	2.36	60
RARM-4	TM50AP-45150, RATM50-45	6.69	170	5.24	150	2.36	60
RARM-5	TM50AP-60150, RATM50-60	7.48	190	5.91	150	3.15	80

Welding Rings

WRARM-1	TM50AP-0775, RATM50-07, TM50AP-1075, RATM50-10, TM50AP-15100, RATM50-15	3.07	78	0.98	25	-	-
WRARM-2	TM50AP-25100, RATM50-25	3.86	98	1.3	33	-	-
WRARM-3	TM50AP-45150, RATM50-45 TM50AP-60150, RATM50-60	4.33	110	1.97	50	-	-

Long or Deep Reaction Arms

LRARM-1	TM50AP-0775, RATM50-07	4.33	110	4.72	120	1.97	50
LRARM-2	TM50AP-1075, RATM50-10, TM50AP-15100, RATM50-15	5.12	130	5.52	140	2.36	60
LRARM-3	TM50AP-25100, RATM50-25	6.69	170	5.91	150	2.36	60
LRARM-4	TM50AP-45150, RATM50-45	6.69	170	7.1	180	2.36	60
LRARM-5	TM50AP-60150, RATM50-60	7.48	190	7.88	200	3.15	80

GRAB WHEEL

The Grab Wheel option offers advantages of reducing labor time and increasing worker safety. In most plants, the operation people are the only ones who manage the valves, which can take 5 to 8 hours to open and close utilizing multiple personnel. With the new Sioux Plarad and Grab Wheel system, one person can do it in less than 30 minutes including set-up. The Plarad weighs about 13 pounds and the grab wheel attachment is about 25 pounds. Once mounted on the spokes of the valve wheel, the operator doesn't have to hold the load. The Grab Wheel comes equipped with short and long spokes for ease of set-up and versatility.

STX22-02-GW

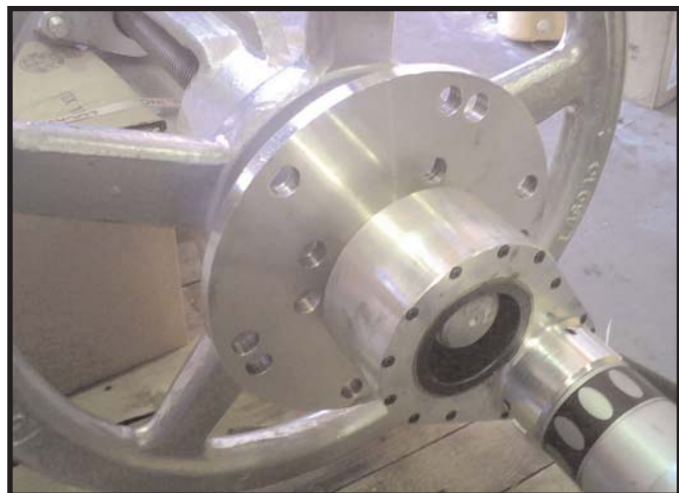

OFF-SET GEAR / REACTION MEMBER MEASUREMENTS

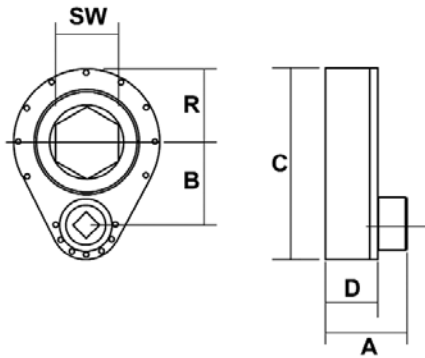

OFF-SET GEAR

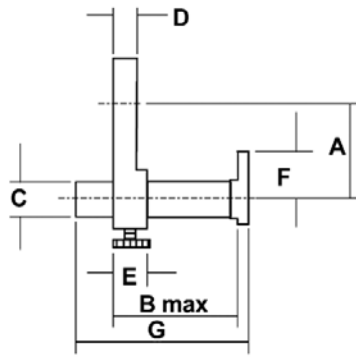

REACTION MEMBER



OFF-SET GEARS

Off-Set Gear Measurements

Model Number	Max Torque		SW		A		B		C		D		R	
	ft lb	Nm	in.	mm	in.	mm	in.	mm	in.	mm	in.	mm	in.	mm
STX22-02-TL	1623	2200	2.56	65	4.1	104	3.2	81	7.49	190	2.6	66	2.52	64
STX36-02-TL	2655	3600	3.94	100	4.18	106	4.39	112	10.02	255	2.68	67	3.82	97

Reaction Member Measurements

Model Number	A		B		C		D		E		F		G		Weight	
	in.	mm	in.	mm	in.	mm	in.	mm	in.	mm	in.	mm	in.	mm	lb	kg
STX22-R	3.27	83	5.52	140	0.79	20	0.79	20	1.18	30	1.97	50	5.91	150	2.6	5.7
STX36-R	3.27	83	5.52	140	1.18	30	0.79	20	1.18	30	1.97	50	5.91	150	3.0	6.6

STX22-02-TL

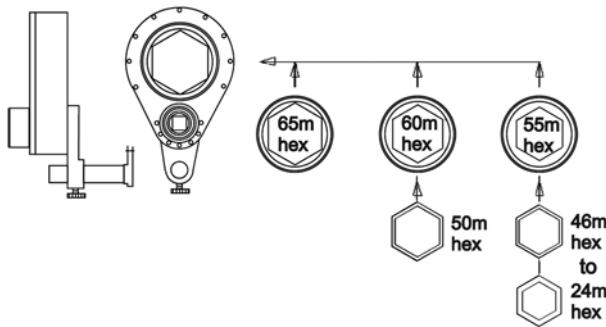

STX36-02-TL

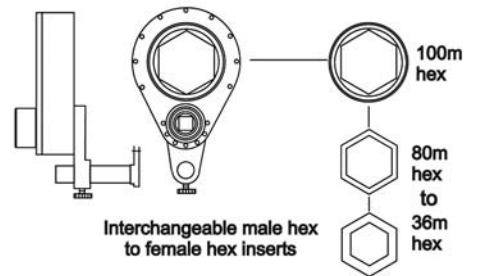

STX22-02-TL Measurements

Model Number	Description
Off-set Gear	
Hex Size	
STX22-02-TL	65
STX22-02-60	60
STX22-02-55	55
Standard Inserts	
Inserts / Standard Inserts	
STX22-H55-24	55 / 24
STX22-H55-30	55 / 30
STX22-H55-32	55 / 32
STX22-H55-36	55 / 36
STX22-H55-41	55 / 41
STX22-H55-46	55 / 46
STX22-H60-50	60 / 50

STX36-02-TL Measurements

Model Number	Description
Off-set Gear	
Hex Size	
STX36-02-TL	100
Standard Inserts	
Inserts / Standard Inserts	
STX36-100-80	100 / 80
STX36-100-75	100 / 75
STX36-100-70	100 / 70
STX36-100-65	100 / 65
STX36-100-60	100 / 60
STX36-100-55	100 / 55
STX36-100-50	100 / 50
STX36-100-46	100 / 46
STX36-100-36	100 / 36

**3/4" (19 mm), 1" (25 mm), 1-1/2" (38 mm)
IMPACT WRENCHES**



IW100HAI-8H



IW75BP-6H



Impact Wrenches

Model Number	Drive Size		Bolt Cap. Grade 5		Working Torque Range*		Maximum Torque		Blows per Minute	Free Speed rpm	Weight		Length		Side to Center		Avg Air Consump.		Socket Retainer Style
	in.	mm	in.	mm	ft lb	Nm	ft lb	Nm			lb	kg	in.	mm	in.	mm	cfm	l/s	
Pistol Grip																			
IW75BP-6H	3/4	19	3/4	19	800	1085	1000	1356	1000	5700	11.6	5.3	7.6	193	1.75	45	15	7	Hole
IW75BP-8H	1	25	3/4	19	825	1119	1100	1492	1000	5700	11.7	5.3	7.6	193	1.75	45	15	7	Hole
D-Handle - Inside Trigger																			
IW100HAI-8H	1	25	1-3/8	35	1600	2170	2000	2710	850	5000	22	10.0	12.4	315	2.0	51	38	18	Hole
IW100HAI-8H6	1	25	1-3/8	35	1600	2170	2000	2710	850	5000	26.2	11.8	18.4	467	2.0	51	38	18	Hole
IW100HAI-5S	#5 Spline		1-3/8	35	1600	2170	2000	2710	850	5000	22	10.0	12.4	315	2.0	51	38	18	Hole
IW100HAI-5S6	#5 Spline		1-3/8	35	1600	2170	2000	2710	850	5000	26.2	11.8	18.4	467	2.0	51	38	18	Hole
IW150HAI-5S	#5 Spline		1-3/8	35	2500	3390	3000	4070	650	3750	33	15.0	14.5	368	2.5	65	60	28	Hole
IW150HAI-12H	1-1/2	38	2	50	2500	3390	3000	4070	650	3750	33	15.0	14.5	368	2.5	65	60	28	Hole

General:

Air Inlet Size: 3/8" NPT
 Recommended Hose Size: 1/2" (13 mm)
 Performance rated @ 90 psig (6.2 bar) air pressure
 Tools available with BSPT air inlet upon request

* Maximum working torque determined by 5 second rundown on appropriate Skidmore-Wilhelm Torque-Tension Tester

Standard Equipment:

Parts list, Safety and Instruction manual
 Suspension Bail
 Support handle (D-handle models)

FOUR BOLT CHIPPING HAMMERS



CH43A-R



Cutoff Tools (1HP)

Model Number	Bore		Stroke		Blows per Minute	Weight		Length		Side to Center		Air Consumption	
	in.	mm	in.	mm		lb	kg	in.	mm	in.	mm	cfm	l/s
Four Bolt Chipping Hammer - Round Front End Bushing													
CH42A-R	1-1/8	29	2.0	50	2100	18	8.0	14.5	370	1-5/8	41	33	15.6
CH43A-R	1-1/8	29	3.0	75	1650	19	8.6	15.5	395	1-5/8	41	34	16.0
CH44A-R	1-1/8	29	4.0	100	1375	20	9.0	16.5	420	1-5/8	41	35	16.5
Four Bolt Chipping Hammer - Hex Front End Bushing													
CH42A-H	1-1/8	29	2.0	50	2100	18	8.0	14.5	370	1-5/8	41	33	15.6
CH43A-H	1-1/8	29	3.0	75	1650	19	8.6	15.5	395	1-5/8	41	34	16.0
CH44A-H	1-1/8	29	4.0	100	1375	20	9.0	16.5	420	1-5/8	41	35	16.5

General:

Air Inlet Size: 7/8-24" NPT
 Recommended Hose Size: 3/8" (10 mm)
 Performance rated @ 90 psig (6.2 bar) air pressure
 Tools available with BSPT air inlet upon request

Standard Equipment:

Parts list, Safety and Instruction manual

NEEDLE SCALERS



SC41011AU-N5



Needle Scalers

Model Number	Stroke Length		Bore Diameter		Blows per Minute	Weight		Length		Side to Center		Air Consumption	
	in.	mm	in.	mm		lb	kg	in.	mm	in.	mm	cfm	l/s
Needle Scaler - Lever Throttle													
SC41011AL-N5	1.1	28	1.0	25	4600	6.3	2.9	15.3	383	1.0	25	12.0	5.7
Needle Scaler - Push/Pull Throttle													
SC41011AU-N5	1.1	28	1.0	25	4600	6.3	2.9	16.8	420	1.0	25	12.0	5.7

General:

Air Inlet Size: 1/4" NPT
 Recommended Hose Size: 3/8" (10 mm)
 Performance rated @ 90 psig (6.2 bar) air pressure
 Tools available with BSPT air inlet upon request

Standard Equipment:

Parts list, Safety and Instruction manual
 5" scaler needles

VERTICAL TYPE 27 WHEEL GRINDERS



HG30AL-80P3



VG20AL-60D7



HG30AL-60S6



Vertical Type 27 Wheel Grinders

Model Number	Free Speed	Wheel Capacity		Weight		Height		Sound Level	Air Consumption Under Load		Air Consumption Free Speed		Spindle Thread
	rpm	in.	mm	lb	kg	in.	mm	dB(A)	cfm	l/s	cfm	l/s	
2.0 hp (1.5 kw) - Class Vertical Grinders													
VG20AL-60D7	6000	7	175	7.4	3.3	5.5	145	85	75	35	26	12	5/8"-11
VG20AL-45D9	4500	9	230	7.4	3.3	5.5	145	85	75	35	26	12	5/8"-11
VG20AL-60D9	6000	9	230	7.4	3.3	5.5	145	85	75	35	26	12	5/8"-11
VG20AL-60C6	6000	6	150	7.4	3.3	5.5	145	85	75	35	26	12	5/8"-11
2.0 hp (1.5 kw) - Class Horizontal Grinders													
HG20AL-60S6	6000	6	150	10.5	4.8	20.8	530	85	75	35	26	12	5/8"-11
HG20AL-45S8	4500	8	200	10.5	4.8	20.8	530	85	75	35	26	12	5/8"-11
HG20AL-80P3	8000	3	75	10.5	4.8	20.8	530	85	75	35	26	12	5/8"-11
3.0 hp (2.2 kw) - Class Vertical Grinders													
VG30AL-60D7	6000	7	175	9.5	4.3	6.4	165	84	90	42	39	18	5/8"-11
VG30AL-45D7	4500	7	175	9.5	4.3	6.4	165	84	90	42	39	18	5/8"-11
VG30AL-45D9	4500	9	230	9.5	4.3	6.4	165	84	90	42	39	18	5/8"-11
VG30AL-60D9	6000	9	230	9.5	4.3	6.4	165	84	90	42	39	18	5/8"-11
VG30AL-60C6	6000	6	150	9.5	4.3	6.4	165	84	90	42	39	18	5/8"-11
3.0 hp (2.2 kw) - Class Horizontal Grinders													
HG30AL-60S6	6000	6	150	12.5	5.6	21.8	550	84	90	42	39	18	5/8"-11
HG30AL-45S8	4500	8	200	12.5	5.6	21.8	550	84	90	42	39	18	5/8"-11
HG30AL-80P3	8000	3	75	12.5	5.6	21.8	550	84	90	42	39	18	5/8"-11

General:

Air Inlet Size: 1/2" NPT
 Recommended Hose Size: 1/2" (13 mm)
 Performance rated @ 90 psig (6.2 bar) air pressure
 Tools available with BSPT air inlet upon request

Standard Equipment:

Parts list, Safety and Instruction manual
 Spindle Wrenches
 Wheel Guard
 Mounting Flange & Nut

DIE GRINDERS / CUTOFF TOOLS



SDG10S25F



SCO10S253F



Die Grinders / Cutoff Tools

Model Number	Free Speed	Weight		Length		Air Consumption		Sound Level	Collet Size/ Wheel Size	Exhaust
	rpm	lb	kg	in.	mm	scfm	l/s	dB(A)		
Straight Die Grinders (1HP)										
SDG10S25F	25,000	1.65	0.75	7.50	190	30	14.2	77.7	1/4"	Front
SDG10S25R	25,000	1.65	0.75	7.50	190	30	14.2	77.7	1/4"	Rear
SDG10S18F	18,000	1.65	0.75	7.50	190	30	14.2	77.7	1/4"	Front
SDG10S18R	18,000	1.65	0.75	7.50	190	30	14.2	77.7	1/4"	Rear
SDG10S12F	12,000	1.65	0.75	7.50	190	30	14.2	77.7	1/4"	Front
SDG10S12R	12,000	1.65	0.75	7.50	190	30	14.2	77.7	1/4"	Rear
Cutoff Tools (1HP)										
SCO10S253F	25,000	2.00	0.90	8.25	210	30	14.2	77.7	3"	Front
SCO10S253R	25,000	2.00	0.90	8.25	210	30	14.2	77.7	3"	Rear

SDG Directional Exhaust Conversion Kit Available. Part Number SDG-EXH

Collet Sizes Available as Accessory

- 1/8" ColletPart Number: 74072
- 3/16" ColletPart Number: 74073
- 1/4" ColletPart Number: 74074
- 3/8" ColletPart Number: 68030

1557 Vacforce

Length		Length		Length		Air Supply	Inlet
in.	mm	in.	mm	lb	kg		
11.0	280	3.75	95	7.6	3.5	2.0 CFM	1/4" NPT

Standard Accessories:

- Adaptor Shims
- 5mm Hex key stored in vacuum base



1557



For the way you work



250 Snap-on Drive
P.O. Box 1596
Murphy, North Carolina USA 28906
PH: 828.835.9765
FAX: 828.835.9685
TOLL FREE: 866.259.7291
TOLL FREE FAX: 800.722.7236

Benelux
Tel.: (N) 31 (0) 20 568 26 63
(B) 32 (0) 14 23 19 67
Fax: (N) 31 (0) 20 568 26 60
(B) 31 (0) 14 23 26 27
e-mail: snap@snap-on.nl

Latin America
Tel.: 305-271-0944
Fax: 305-271-7152
e-mail: latinamerica.caribbean@snapon.com

Germany
Tel.: 49 2104 9509-0
Fax: 49 2104 9509-99
e-mail: snapon.industrial@snapon.com

Italy
Tel.: 00 39 02 66 04 53 70
Fax: 00 39 02 61 29 78 15
e-mail: indus.italia@snapon.com

United Kingdom
Tel.: 44 (0) 1536-413904
Fax: 44 (0) 1536-413874
e-mail: industrialuk@snapon.com

Asia
Tel.: 65-6451-5570
Fax: 65-6451-5574
email: esales.sg@snapon.com

Australia
Tel.: 61 2 9837 9100
Fax: 61 2 9624 2578
e-mail: SOTA.customerservice@snapon.com

Distributed By:

